

**////// ZERO-MAX<sup>®</sup>**

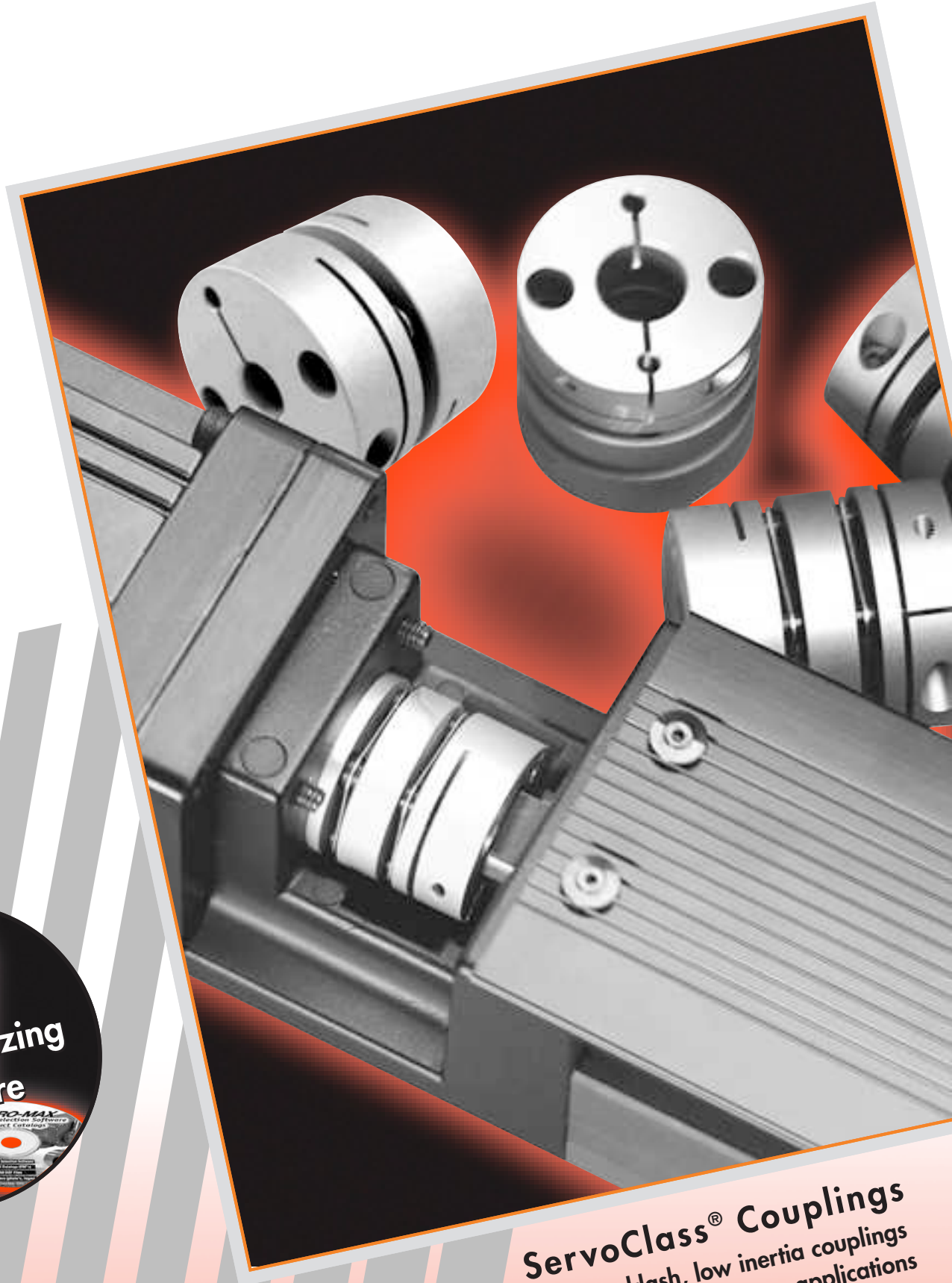

**ServoClass<sup>®</sup> Couplings**  
Zero-backlash, low inertia couplings  
for precision servomotor applications

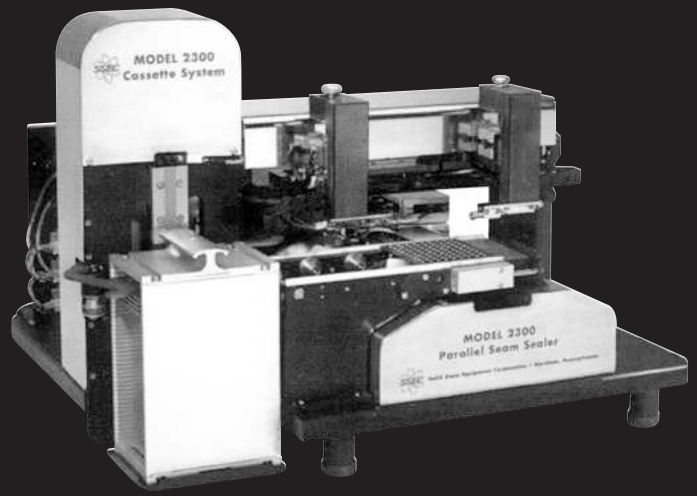
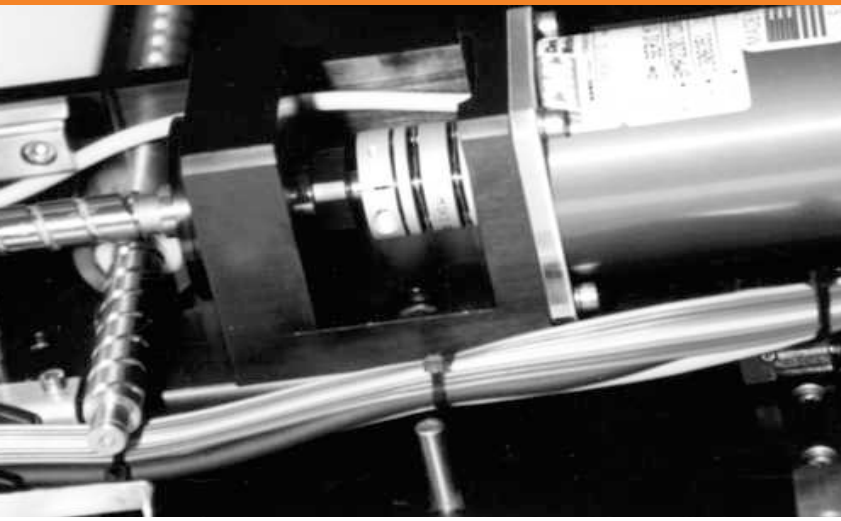

# SC ServoClass® Couplings

## Zero-Max ServoClass Couplings



Zero-Max's ServoClass Couplings are specifically designed to meet the precision positioning requirements and high reverse-load characteristics common to many of today's AC and DC servomotor applications.

Zero-Max introduced the ServoClass coupling in 1996 specifically for the servomotor market and is rapidly becoming the market leader. The coupling incorporates many features required in a demanding servo application. Some of these features include low inertia, high torsional stiffness, zero backlash and a good misalignment capability.

### Important Considerations

The features listed above all play a crucial role in the resonance and natural frequency of a servo system. Every system must take into account the mechanical as well as the electrical attributes in order to perform properly. Many times the electrically focused assumes the mechanical part of the system will keep up with the electronic commands of the controller. The mechanically focused are many times insensitive to the electronic frequencies that are being transmitted into the system through the coupling. The features and specifications of the ServoClass coupling aid in making these two areas work well together.

**Inertia and torsional stiffness** are two main factors in a superior servo coupling. The inertia should be low so as not to add significantly to the overall inertia of the servo system. The lower the inertia, the less energy required by the motor to move the system and therefore, higher acceleration is possible. The torsional stiffness should be high enough to prevent the coupling from winding up during acceleration, deceleration or reversing conditions. The torsional stiffness of the ServoClass coupling leads to a higher system resonant frequency, which in most cases, is far above the operating range.



**ServoClass Single Disc Model, Page 6**

Smaller package, with higher torsional and axial stiffness



**Quality servo couplings** should have zero backlash. A coupling may be considered zero backlash and still have a large amount of wind up. Zero backlash is the ability of the coupling to maintain the same relative relationship between the input and the output shaft without lost motion. The windup of the coupling can be detrimental to the servo system. A coupling with a high amount of wind up will cause positioning errors to the servo system. The ServoClass coupling is a zero backlash coupling and it exhibits a very low amount of wind up.

**The misalignment capability** of a coupling is also important in a motion control system. For the most part, the alignment of a well manufactured servo system will be very good. Over time, or under higher loads, this alignment may deteriorate and the coupling should be capable of handling this change. The coupling should also accommodate such things as the lack of concentricity in the shafts being connected and the stack up of tolerances in the assembly. Another benefit of a high misalignment capability is the dispersion of reaction loads on the bearings and bushings in the system. The ServoClass coupling utilizes a disc design that provides adequate amounts of flexibility but does not sacrifice any of the torque capability or the torsional stiffness capability and therefore minimizing the reaction loads to the servo motor bearings.



**ServoClass Double Disc Model, Page 7**  
Greater misalignment capability

## ServoClass Overview

The ServoClass coupling product line consists of eighteen coupling sizes. There are nine models of the "double disc" design and nine models of the "single disc" design. The double disc design provides more misalignment capability and the single disc design provides a smaller package coupling with more torsional and axial stiffness than the double disc design!

**Operating torque** ratings for the couplings range from 4.43 lb-in up to 885 lb-in. These torque ratings are based on the minimum bore for the coupling. The line can accommodate bore sizes from 4.0 mm up to a maximum of 35 mm. (Contact Zero-Max for bore sizes smaller or larger than listed as standard.)

**The ServoClass coupling** hubs and center members are manufactured from 7075 aluminum and heat-treated for high strength and durability. These members are also steam treated to help prevent oxidation and preserve the coupling appearance. The flexible disc members are constructed of type 304 stainless steel.

**The entire coupling** is precisely assembled using the highest strength threaded fasteners. The coupling design also provides an integral clamp style hub for mounting the coupling. This hub design allows the ordering of either inch, mm hub bores or combinations of each type.



Disc members are made of 304 Stainless Steel and provide for torsional stiffness and some misalignment capability.

## Standard Motor Application

1. Determine the speed-revolutions per minute (RPM) and horsepower (HP). Then calculate the torque (T), in inch-pounds, to be transmitted:

$$T = \frac{HP \times 63,025}{RPM}$$

2. Select the service factor (K) according to the characteristics of the load or application. See chart below for load characteristics and service factor. Calculate the coupling selection torque (TD) based on the appropriate service factor:

$$TD = T \times K$$

3. Select a coupling with a torque rating equal or greater than TD.
4. Check the dimensions and bore range of the coupling selected with the application requirements.

## Servomotor Application

Although servomotors have different torque values relative to RPM, and torque values change relative to continuous or intermittent duty, it is suggested to use the peak torque rating of the servomotor multiplied by a service factor in determining the coupling selection:

$$TS = TM \times KS$$

TS is the torque used to select the coupling; TM is the peak torque of the servomotor; KS is the servo service factor of the application. Generally, KS is a value within the range of 1.3 to 1.5 for ServoClass coupling applications. 1.3 is a factor applied to typical reverse-load, continuous-duty applications. 1.5 is a factor applied to the most demanding high reverse-load, rapid-acceleration applications. Example:

Servomotor Peak Torque: 7.59 inch-pounds  
 Rated Torque: 2.53 inch-pounds  
 Shaft Diameter: .375 inch

$$TS = 7.59 \times 1.5$$

$$TS = 11.39 \text{ inch-pounds of torque}$$

Coupling selection: SC 020, rated at 13 inch-pounds of torque. .375 bore is OK.

## Natural Frequency & Resonance

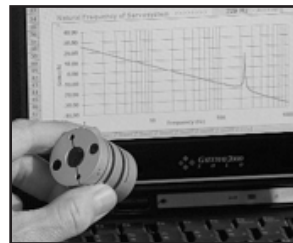

In servomotor systems, torsional vibration can be caused by acceleration, deceleration, driver characteristics and other factors. While torsional vibration is inherent in power transmission systems, it is important that its frequency and amplitude be

minimized. Torsional vibration can cause component failure or poor system performance. By selecting the proper coupling that places the natural frequency outside the range of 150-400 Hz, the effects of torsional vibration or resonance can be reduced. The calculated natural frequency of the system should be 1.3 to 1.5 times greater than this range.

The natural torsional frequency can be calculated from a 2 mass system approximation using the following equation.

$$F = 1/2\pi \times \sqrt{\frac{K \times (J_1 + J_2)}{J_1 \times J_2}}$$

Where:



F = Natural Frequency in Hz

J<sub>1</sub> = Inertia of the Motor

J<sub>2</sub> = Inertia of the load

K = Torsional Stiffness of the Coupling

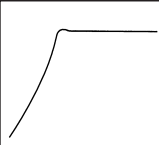
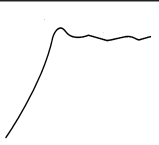
Other factors such as system gain, elasticity of the system and dampening can also be included in the equation. Please call us for a natural frequency analysis of your servo system.

Load Characteristics			
Constant	Slight fluctuation	Medium fluctuation	Great fluctuation
			
1.0	1.25	1.75	2.25

## Additional ServoClass Coupling Applications

The ServoClass coupling was designed specifically for the servo motor market. Other applications include stepper motors and encoders. Typically these motors are used in applications that involve positioning devices such as linear ball screws, actuators, and positioning systems (X, Y and Z-axis). The ServoClass is ideal for use in machine tools, printing machines, pick and place machines and many other high precision applications. If there's a servomotor in the system, a ServoClass coupling should be used!

## Sizing software for ServoClass Couplings

Zero-Max provides free software on a CD ROM to help select and size the correct ServoClass Coupling. This CD ROM contains all Zero-Max product catalogs in a PDF format, a comprehensive sizing and selection program and CAD drawings for most of the Zero-Max products.

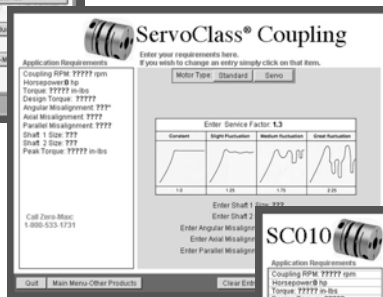

The sizing and selection portion of the software walks the user through the selection of any Zero-Max product and gives a recommendation on which model to use.

The software is very user friendly and can be used on any Windows or Macintosh based computer.

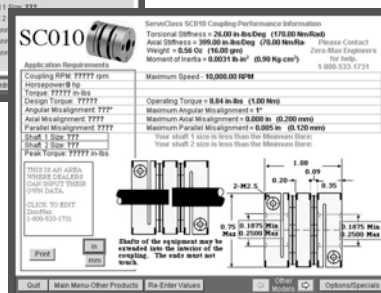

## Installation

The ServoClass Coupling is furnished as a one piece assembly and should not be disassembled. After installation of the coupling, tighten the hub clamping screws to the specified torque. A torque wrench is recommended.

Size	Tightening Torque inch-pounds (Nm)
SC 005	3.5
SD 005	(.4)
SC 010	9
SD 010	(1)
SC 020	9
SD 020	(1)
SC 030	13
SD 030	(1.5)
SC 035	30
SD 035	(3.4)
SC 040	30
SD 040	(3.4)
SC 050	62
SD 050	(7)
SC 060	121
SD 060	(14)
SC 080	292
SD 080	(33)

# SC ServoClass® Couplings

## Single Disc Model

### Specifications & Dimensions

#### SD Series



Size	Bore d1 & d2		Outside Diameter D	Overall Length L	Hub Length LB	Spacer Gap S	Clamp Screw Size M
	Min inch mm	Max inch mm					
SD005	0.157 4.0	0.236 6.0	0.63 16.0	0.63 16.0	0.295 7.5	0.039 1.0	2-M2.0
SD010	0.1875 4.0	0.250 7.0	0.75 19.0	0.78 19.9	0.35 9.0	0.075 1.9	2-M2.5
SD020	0.250 5.0	0.375 10.0	1.02 26.0	0.93 23.5	0.41 10.5	0.098 2.5	2-M2.5
SD030	0.250 6.0	0.500 14.0	1.34 34.0	1.07 27.1	0.47 12.0	0.122 3.1	2-M3.0
SD035	0.375 8.0	0.625 16.0	1.54 39.0	1.34 34.1	0.59 15.0	0.161 4.1	2-M4.0
SD040	0.375 8.0	0.750 19.0	1.73 44.0	1.34 34.1	0.59 15.0	0.161 4.1	2-M4.0
SD050	0.4375 10.0	1.000 25.0	2.20 56.0	1.77 45.0	0.79 20.0	0.197 5.0	2-M5.0
SD060	0.625 15.0	1.125 30.0	2.68 68.0	2.13 54.0	0.95 24.0	0.240 6.0	2-M6.0
SD080	0.8125 20.0	1.375 35.0	3.23 82.0	2.99 76.0	1.18 30.0	0.320 8.0	2-M8.0

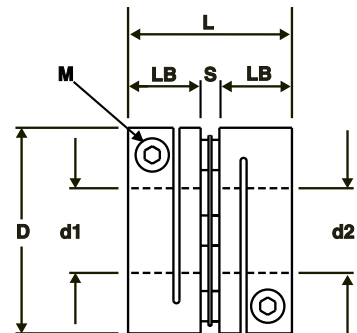

Size	Operating Torque in-lb Nm	Maximum RPM r/min	Torsional Stiffness in-lb/deg Nm/rad	Axial Stiffness lb/in N/mm	Misalignment Capacity			Moment of Inertia lb-in <sup>2</sup> kgm <sup>2</sup> (x10 <sup>6</sup> )	Weight Oz gm
					Parallel inch mm	Angular degree	Axial +/- inch +/- mm		
SD005	4.43 0.5	10,000	43.3 280	800 140	-	0.5	0.002 0.05	0.0009 0.264	0.245 7
SD010	8.84 1.0	10,000	34 220	800 140	-	1.0	0.004 0.1	0.0023 0.67	0.42 12
SD020	13 1.5	10,000	116 750	365 64	-	1.0	0.006 0.15	0.0068 2.0	0.88 25
SD030	27 3.0	10,000	263 1,700	365 64	-	1.0	0.08 0.20	0.0259 7.6	1.55 44
SD035	53 6.0	10,000	402 2,600	320 56	-	1.0	0.010 0.25	0.0659 19.3	2.93 83
SD040	80 9.0	10,000	541 3,500	229 40	-	1.0	0.012 0.30	0.0922 27.0	3.21 91
SD050	221 25.0	10,000	1,328 8,600	274 48	-	1.0	0.016 0.40	0.3594 105.3	7.80 221
SD060	530 60.0	10,000	3,398 22,000	434 76	-	1.0	0.018 0.45	1.0679 312.9	15.87 450
SD080	885 100.0	10,000	6,178 44,000	314 55	-	1.0	0.022 0.55	2.7986 820.0	35.27 1,000

\*SD series couplings are not recommended where parallel misalignment is required or anticipated.

# Double Disc Model

## Specifications & Dimensions

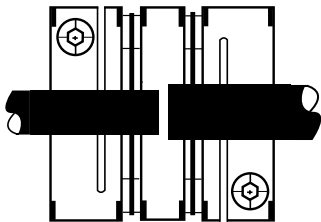
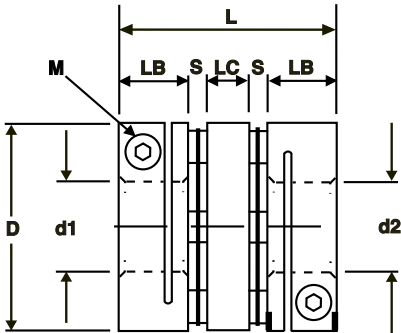

The shafts of the equipment (up to the maximum bore size of the coupling) may be extended into the interior of the coupling without any modification to the ServoClass coupling. However, the ends of the shafts must never touch each other.

### SC Series

ServoClass Double Disc Dimensions								
Size	Bore d1 & d2		Outside Diameter D	Overall Length L	Hub Length LB	Center Member LC	Spacer Gap S	Clamp Screw Size M
	Min	Max						
	inch	mm						
SC005	0.157 4.0	0.236 6.0	0.63 16.0	0.87 22.0	0.295 7.5	0.20 5.0	0.039 1.0	2-M2.0
SC010	0.1875 4.0	0.250 7.0	0.75 19.0	1.08 27.5	0.35 9.0	0.20 5.0	0.089 2.25	2-M2.5
SC020	0.250 5.0	0.375 10.0	1.02 26.0	1.26 32.0	0.41 10.5	0.24 6.0	0.098 2.5	2-M2.5
SC030	0.250 6.0	0.500 14.0	1.34 34.0	1.46 37.0	0.47 12.0	0.28 7.0	0.118 3.0	2-M3.0
SC035	0.375 8.0	0.625 16.0	1.54 39.0	1.85 47.0	0.59 15.0	0.35 9.0	0.158 4.0	2-M4.0
SC040	0.375 8.0	0.750 19.0	1.73 44.0	1.85 47.0	0.59 15.0	0.35 9.0	0.158 4.0	2-M4.0
SC050	0.4375 10.0	1.000 25.0	2.20 56.0	2.40 61.0	0.79 20.0	0.43 11.0	0.220 5.5	2-M5.0
SC060	0.625 15.0	1.125 30.0	2.68 68.0	2.91 74.0	0.95 24.0	0.55 14.0	0.240 6.0	2-M6.0
SC080	0.8125 20.0	1.375 35.0	3.23 82.0	3.86 98.0	1.18 30.0	0.87 22.0	0.320 8.0	2-M8.0

ServoClass Double Disc Specifications									
Size	Operating Torque in-lb Nm	Maximum RPM r/min	Torsional Stiffness in-lb/deg Nm/rad	Axial Stiffness lb/in N/mm	Misalignment Capacity			Moment of Inertia lb-in <sup>2</sup> kgm <sup>2</sup> (x10 <sup>6</sup> )	Weight Oz gm
					Parallel inch mm	Angular degree	Axial +/- inch +/- mm		
SC005	4.43 0.5	10,000	30.5 200	399 70	0.002 0.05	0.5	0.004 0.1	0.0013 0.386	0.35 10
SC010	8.84 1.0	10,000	26 170	399 70	0.005 0.12	1.0	0.008 0.2	0.0031 0.9	0.56 16
SC020	13 1.5	10,000	90 580	182 32	0.006 0.15	1.0	0.013 0.33	0.0103 3.0	1.23 35
SC030	27 3.0	10,000	201 1,300	182 32	0.007 0.17	1.0	0.016 0.40	0.0359 10.5	2.19 62
SC035	53 6.0	10,000	309 2,000	160 28	0.009 0.22	1.0	0.020 0.50	0.0899 26.3	4.09 116
SC040	80 9.0	10,000	417 2,700	114 20	0.009 0.22	1.0	0.024 0.60	0.1299 38.0	4.62 131
SC050	221 25.0	10,000	973 6,300	137 24	0.010 0.27	1.0	0.031 0.80	0.4931 144.3	10.65 302
SC060	530 60.0	10,000	2,780 18,000	218 38	0.013 0.34	1.0	0.035 0.90	1.3089 383.5	19.40 550
SC080	885 100.0	10,000	5,097 33,000	157 27	0.020 0.52	1.0	0.043 1.10	3.6860 1,080	42.30 1,200

# Additional Zero-Max® Motion Control Products



## ETP® Bushings

Locks hub to shaft easily without troublesome keys. 26 sizes from 3/4" to 4". Metrics from 8 mm to 100 mm. Stainless steel models.



## Zero-Max® Adjustable Speed Drives

Variable 0 to 400 RPM outputs from constant input speeds to 2,000 RPM. Torques 12 to 200 in. lbs.



## Torq-Tender®

Accurate overload protection. Dis-engage torques to 3,000 in. lbs. Bores 1/8" to 1-3/4".



## Schmidt Couplings

Offset, In-line, Elastomeric and Control-Flex models. Sizes 5 to 500,000 inch lbs. torque.

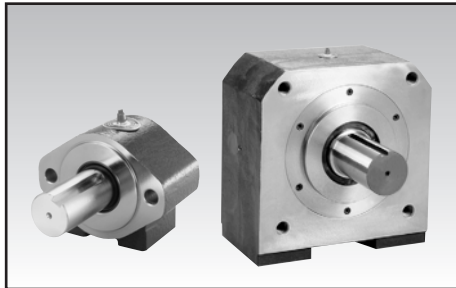

## OHLA® - Overhung Load Adapters

Overhung Load Adapters prevent failures. A thru F mounts. Keyed and spline shafts. Speeds to 3600 RPM. Specials.

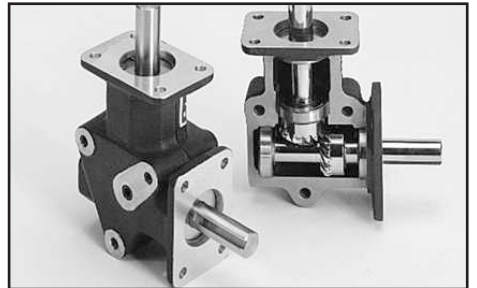

## Crown Right Angle Gear Drives

Two and three way models with 1:1 and 2:1 ratios. Spiral bevel gears. 3/8 to 1 inch dia. Stainless steel shafts.



## CD® Couplings

Composite disc design that outperforms steel discs and elastomeric models. Torsional stiffness. 3° misalignment. Torques to 500,000 in. lbs.



## Posi-Lok® Shaft Bushings

Inch and Metric sizes to 35 mm. Nickel plating offers corrosion protection.

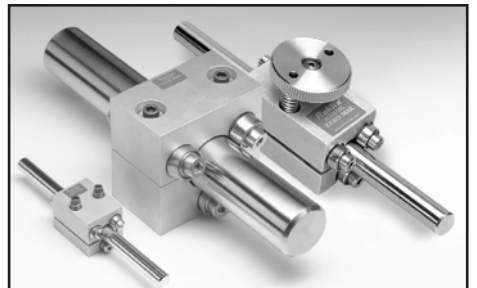

## Roh'lix® Linear Actuators

Convert rotary motion into precise linear motion. Five models with 3/8" to 2" dia. shafts. Thrust ratings to 200 lbs. Overload protection.

## WARRANTY

Zero-Max, Inc. the manufacturer, warrants that for a period of 12 months from date of shipment it will repair, or at its option, replace any new apparatus which proves defective in material or workmanship, or which does not conform to applicable drawings and specifications approved by the manufacturer. All repairs and replacements shall be F.O.B. factory. All claims must be made in writing to the manufacturer.

In no event and under no circumstances shall manufacturer be liable for (a) damages in shipment; (b) failures or damages due to misuse, abuse, improper installation or abnormal conditions of temperature, dirt, water or corrosives; (c) failures due to operation, intentional or otherwise, above rated capacities, and (d) non-authorized expenses for removal, inspection, transportation, repair or rework. Nor shall manufacturer ever be liable for consequential and incidental damages, or in any amount greater than the purchase price of the apparatus.

Zero Max, Inc. reserves the right to discontinue models or to change specifications at any time without notice. No discontinuance or change shall create any liability on the part of Zero-Max, Inc. in respect to its products in the hands of customers or products on order not incorporating such changes even though delivered after any such change.

This warranty is in LIEU OF ALL OTHER WARRANTIES, EXPRESS OR IMPLIED, INCLUDING (BUT NOT LIMITED TO) ANY IMPLIED WARRANTIES OF MERCHANTABILITY OR FITNESS FOR A PARTICULAR PURPOSE. THE TERMS OF THIS WARRANTY CONSTITUTE ALL BUYER'S OR USER'S SOLE AND EXCLUSIVE REMEDY, AND ARE IN LIEU OF ANY RIGHT TO RECOVER FOR NEGLIGENCE, BREACH OF WARRANTY, STRICT TORT LIABILITY OR UPON ANY OTHER THEORY. Any legal proceedings arising out of the sale or use of this apparatus must be commenced within 18 months of the date of purchase.

**CAUTION:** Rotating equipment must be guarded. Also refer to OSHA specifications and recommendations.

Zero-Max®, CD®, ETP®, ServoClass®, Torq-Tender®, Control-Flex®, Posi-Lok® and Roh'Lix® are registered trademarks of Zero-Max, Inc. OHLA™ is a trademark of Zero-Max, Inc.

© Zero-Max 2004 Printed in U.S.A.

# ////// ZERO-MAX®

13200 Sixth Avenue North, Plymouth, Minnesota 55441-5509  
800-533-1731 • (763) 546-4300 • Fax (763) 546-8260 • www.zero-max.com